

Date	02.06.2017
Ed. by.	Schuhmacher
Creat.	Schuhmacher
Drw.No.	

Festo Didactic SE
 Rechbergstraße 3
 D-73770 Denkendorf



Aufbauplan
 assembly

S-Nr.
D13012
 PSP / DPI VN

= E	Heat tunnel	
++		Page 4
+ EB	Heat tunnel	of

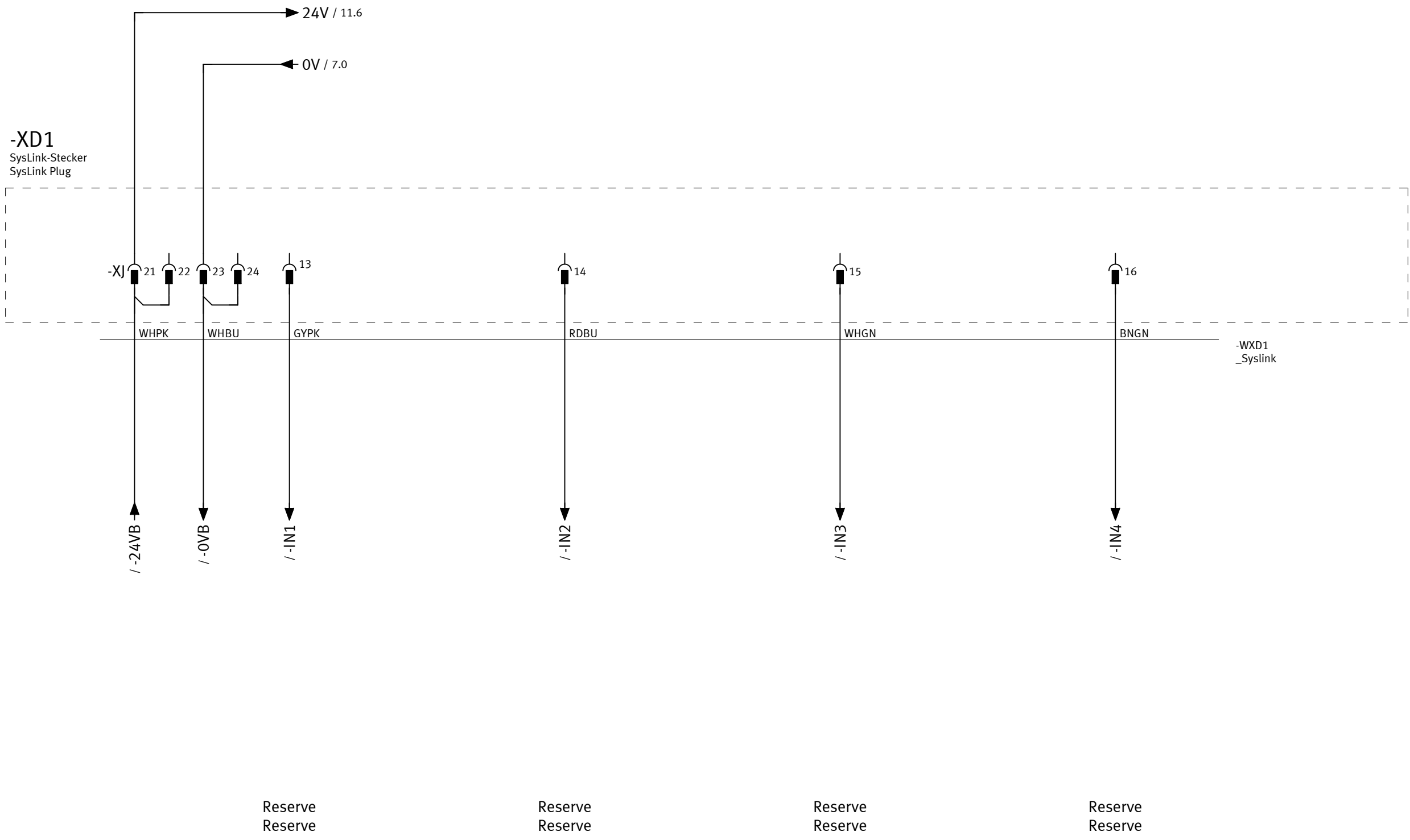

-XD1
 SysLink-Stecker
 SysLink Plug



-XJ 17

18

19

20

WHYE

YEEN

WHGY

GYBN

-WXD1
 _Syslink

/-IN5

/-IN6

/-IN7

/-IN8

Reserve
 Reserve

Reserve
 Reserve

Reserve
 Reserve

Reserve
 Reserve

Date	08.08.2017
Ed. by.	Schuhmacher
Creat.	Schuhmacher
Drw.No.	

Festo Didactic SE
 Rechbergstraße 3
 D-73770 Denkendorf



Eingänge
 inputs

S-Nr.	D13012
PSP / DPJ	VN

= E	Heat tunnel	
++		Page 6
+ EB	Heat tunnel	of

Diese Zeichnung ist Eigentum der Festo Didactic SE This Drawing is copyright by Festo Didactic SE

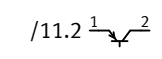
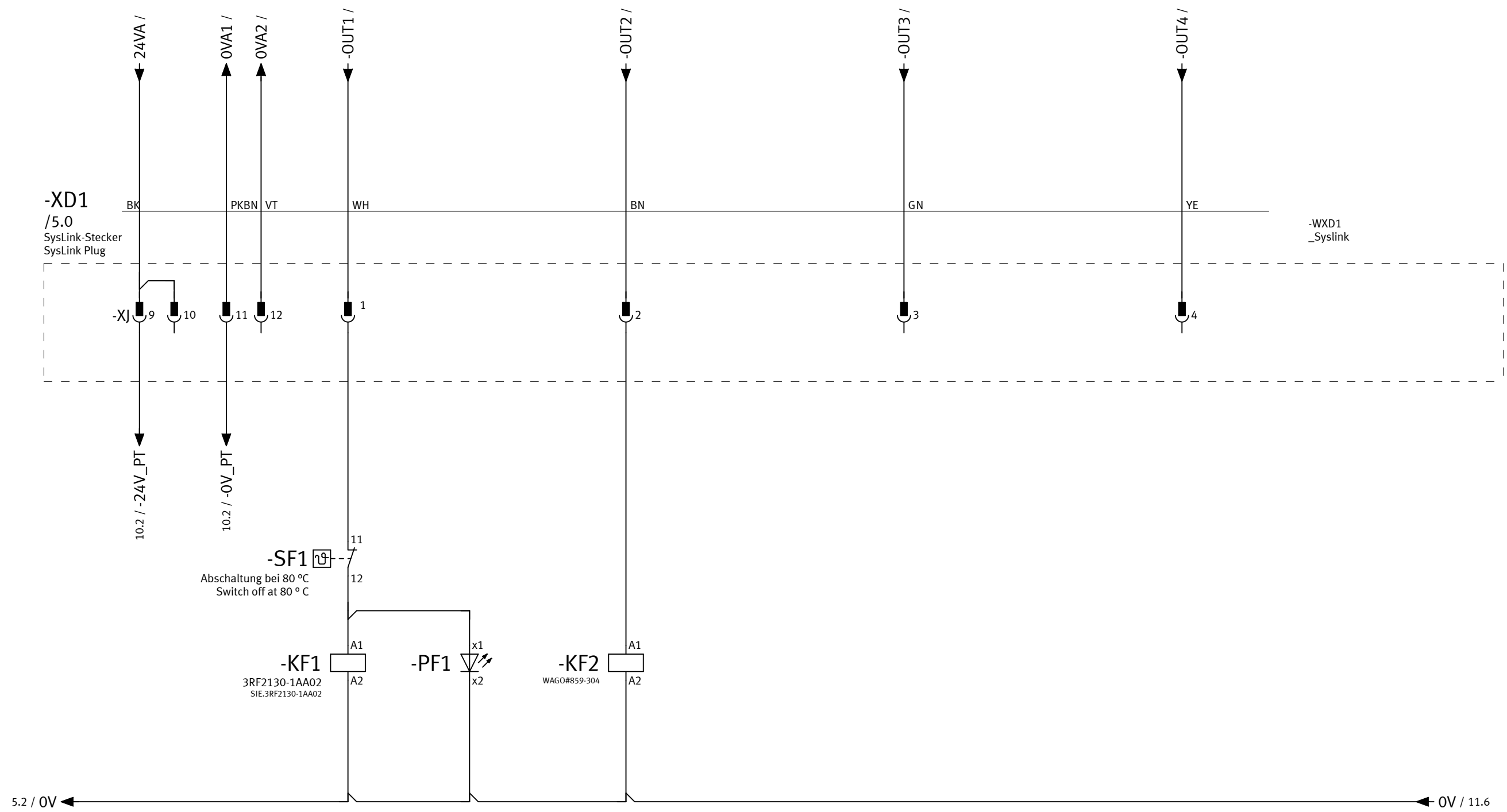

Heizung
einschalten
heater
turn on

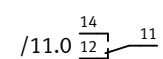

heizleistung
heating capacity

Reserve
Reserve

Reserve
Reserve

<<6

8>>

Date	08.08.2017
Ed. by.	Schuhmacher
Creat.	Schuhmacher
Drw.No.	

Festo Didactic SE
Rechbergstraße 3
D-73770 Denkendorf



Ausgänge
outputs

S-Nr.	D13012
PSP / DPJ	VN

= E	Heat tunnel	
++		Page 7
+ EB	Heat tunnel	of

N:Raster08 F: WUP0U30238 Q:\GRP-0200\2_Technik\EPLAN\VP8\Projekte\Festo\26 CP-App-Module\01.01 CP-AM-HEIZUNG

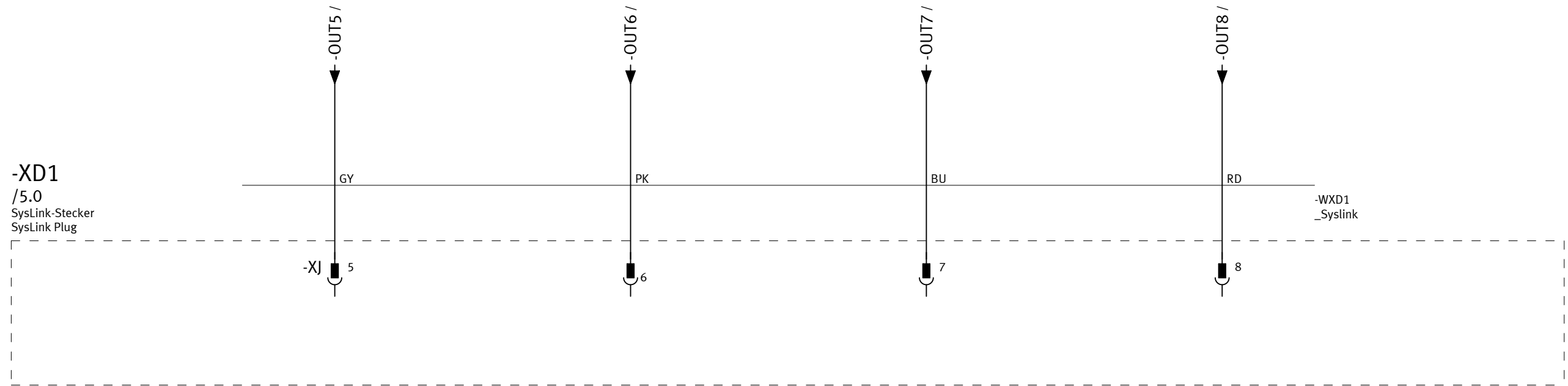

Reserve
Reserve

Reserve
Reserve

Reserve
Reserve

Reserve
Reserve

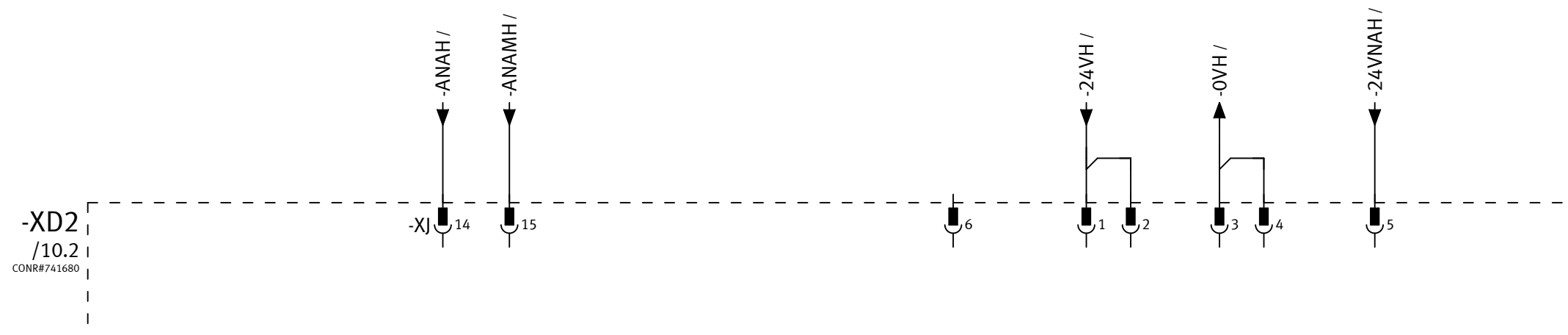

Date	02.06.2017
Ed. by.	Schuhmacher
Creat.	Schuhmacher
Drw.No.	

Festo Didactic SE
 Rechbergstraße 3
 D-73770 Denkendorf



Analogausgang - Reserve
 Analog Output - Reserve

S-Nr.	D13012
PSP / DPJ	VN

= E	Heat tunnel
++	
+ EB	Heat tunnel

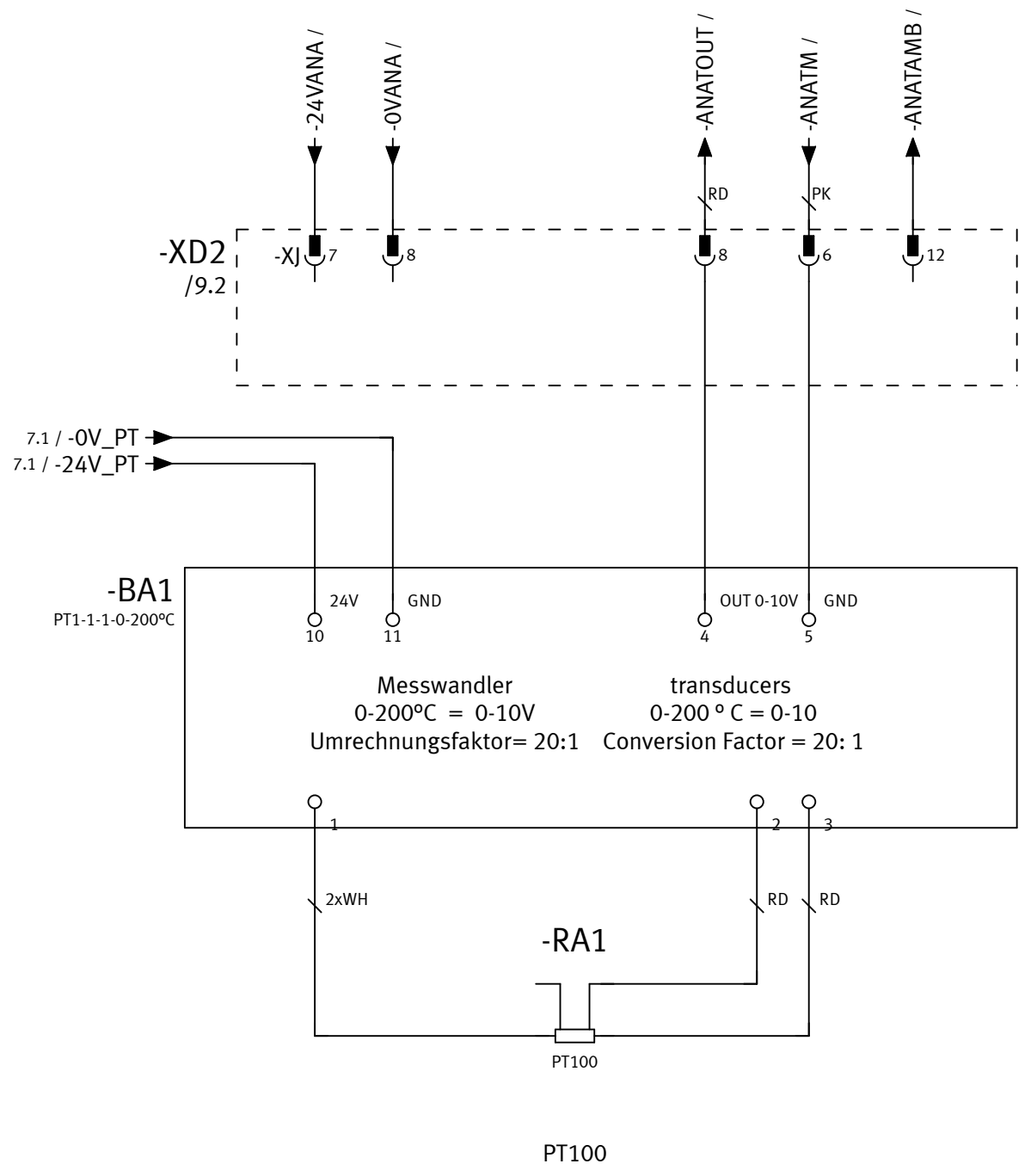

Diese Zeichnung ist Eigentum der Festo Didactic SE This Drawing is copyright by Festo Didactic SE

