



# &EAB

# Inhaltsverzeichnis Table of contents

Datum	30.04.2021	Festo Didactic SE Rechbergstraße 3 D-73770 Denkendorf	<b>FESTO</b>	Übersicht Overview	S-Nr. 8155207				
Bearb.	espe				PSP / DPJ	VN	= B	Kamerainspektion	Seite 2
Erst.	espe						+		von 14
Ze.Nr.	Z13.E11	N:	F:	EPL0VZFG7M \\vesto.net\DFS01\INTData\EPLAN\DATA_xx\DE\Projects\Didactic\Products\26 CPAM\Cam\8155207_CP-AM-CAM-V2.elk					



Diese Zeichnung ist Eigentum der Festo Didactic SE. This drawing is the property of Festo Didactic SE.

# &EDB

# Systembeschreibung

<&EAB/3

5>>

Datum	30.04.2021	Festo Didactic SE Rechbergstraße 3 D-73770 Denkendorf		Übersicht Overview	S-Nr. <b>8155207</b>				
Bearb.	espe				PSP / DPJ	VN	= B	Kamerainspektion	Seite 4
Erst.	espe						+		von 14
Ze.Nr.	Z13.E11	N:	F:	EPL0VZFG7M	\\Festo.net\DFS01\INTData\EPLAN\DATA_xx\DE\Projects\Didactic\Products\26 CPAM\Cam\8155207_CP-AM-CAM-V2.elk				

Diese Zeichnung ist Eigentum der Festo Didactic SE. This drawing is the property of Festo Didactic SE.

## Projekteigenschaften project properties

Festo Kamera camera

<4

+BX&/6>>

Datum	30.04.2021	Festo Didactic SE Rechbergstraße 3 D-73770 Denkendorf	<b>FESTO</b>	Projekteigenschaften project properties	S-Nr.	8155207	= B	Kamerainspektion	Seite	5	
Bearb.	espe				PSP / DPJ	VN			+	von	14
Erst.	espe										
Ze.Nr.	Z13.E11	N:	F:	EPL0VZFG7M	\\Festo.net\DFS01\INTData\EPLAN\DATA_xx\DE\Projects\Didactic\Products\26 CPAM\Cam\8155207_CP-AM-CAM-V2.elk						

# +BX

# Kamerainspektion

Datum	30.04.2021	Festo Didactic SE Rechbergstraße 3 D-73770 Denkendorf	<b>FESTO</b>	Übersicht overview	S-Nr.	8155207			
Bearb.	espe				PSP / DPJ	VN	= B	Kamerainspektion	Seite 6
Erst.	espe						+ BX	Kamerainspektion	von 14
Ze.Nr.	Z13.E11	N:	F:	EPL0VZFG7M	\\Festo.net\DFS01\INT\Data\EPLAN\DATA_xx\DE\Projects\Didactic\Products\26 CPAM\Cam\8155207_CP-AM-CAM-V2.elk				

Diese Zeichnung ist Eigentum der Festo Didactic SE. This drawing is the property of Festo Didactic SE.

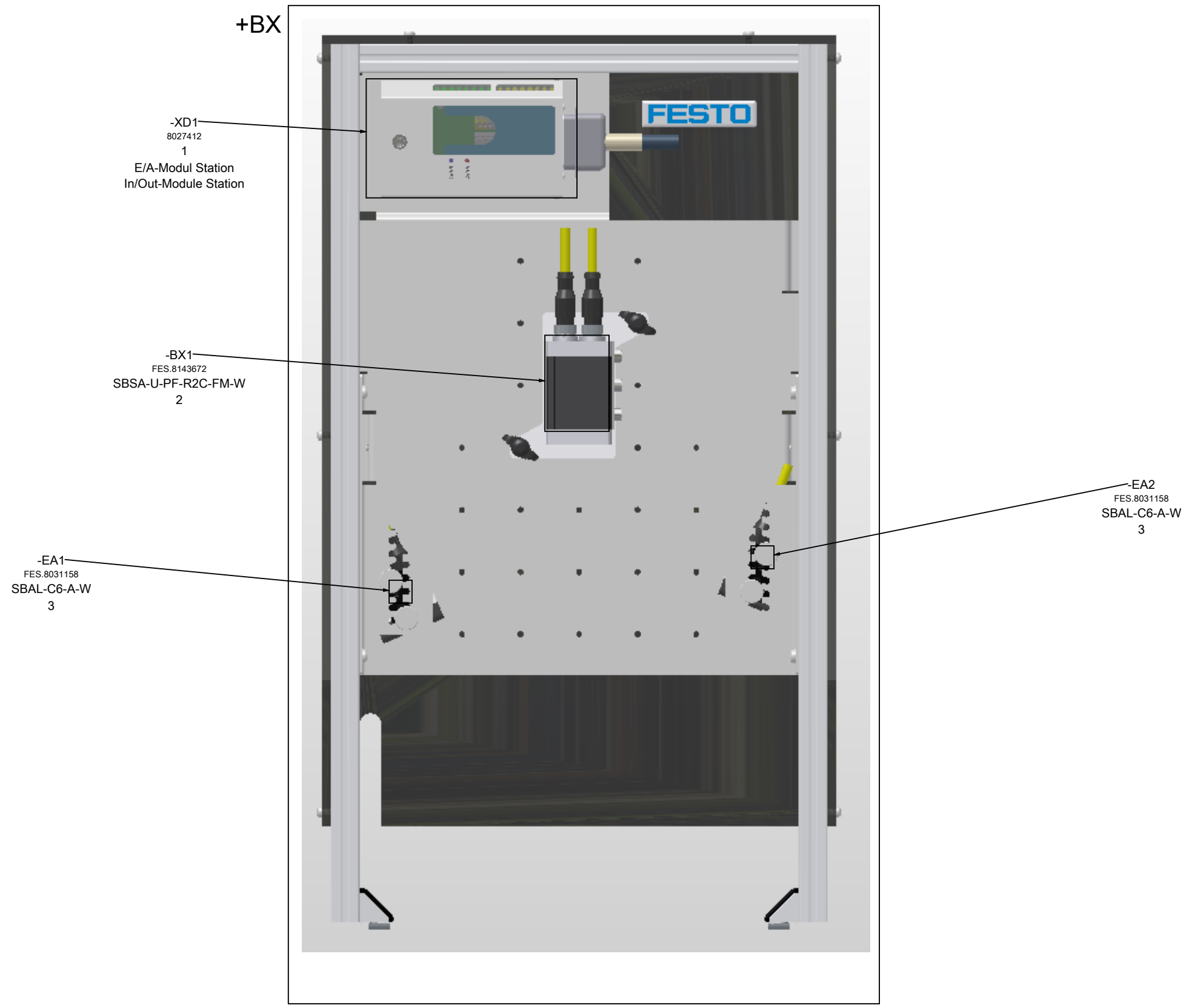

<6

8>>

Datum	30.04.2021	Festo Didactic SE Rechbergstraße 3 D-73770 Denkendorf
Bearb.	espe	
Erst.	espe	
Ze.Nr.	Z13.E11	



**Aufbauplan  
assembly**

S-Nr.  
**8155207**  
PSP / DPJ VN

= B	Kamerainspektion	Seite 7
+ BX	Kamerainspektion	von 14

Diese Zeichnung ist Eigentum der Festo Didactic SE

**-XD1**  
/8.0  
E/A-Modul Station  
In/Out-Module Station

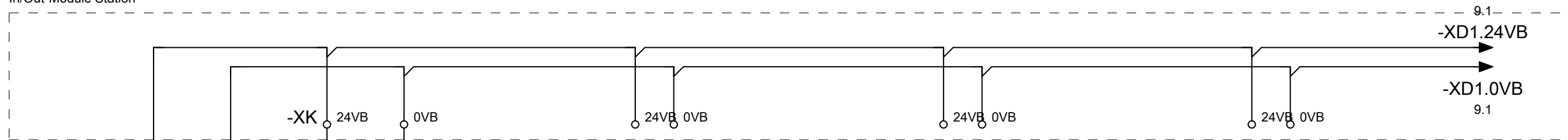

**-XD1**  
E/A-Modul Station  
In/Out-Module Station

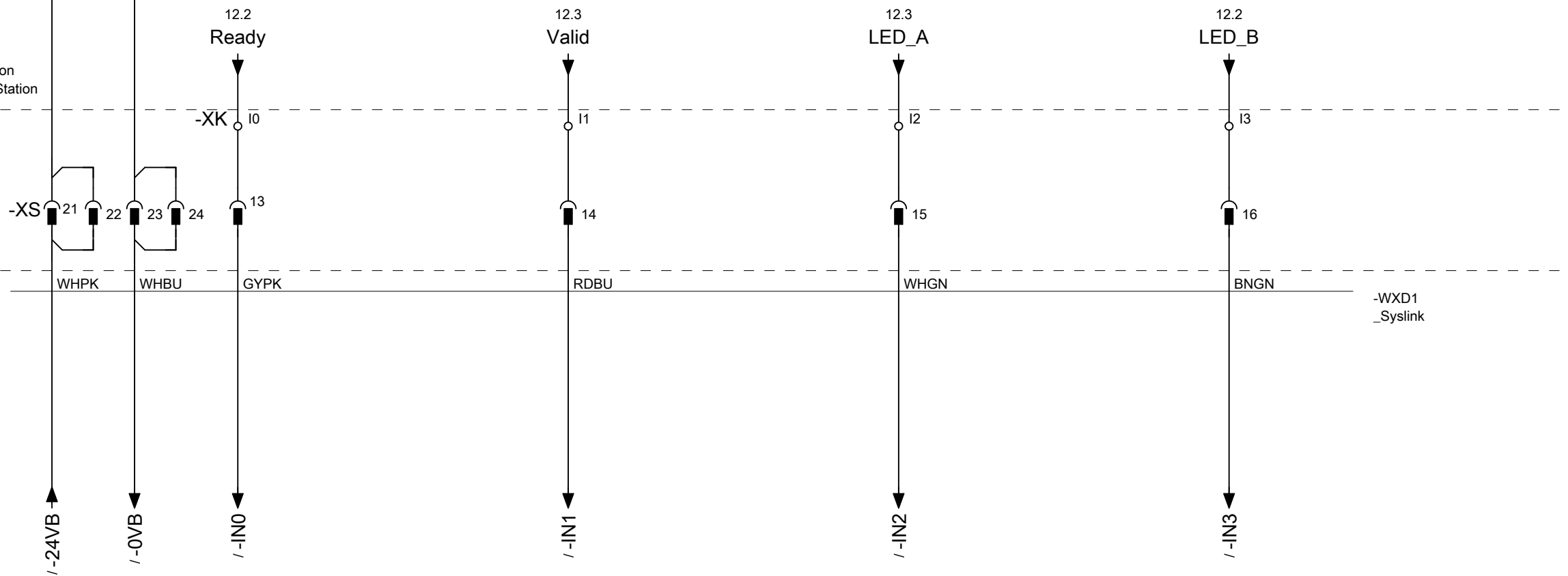

Ready

Valid

LED A

LED B

Datum	30.04.2021	Festo Didactic SE Rechbergstraße 3 D-73770 Denkendorf		<b>FESTO</b>	Eingänge inputs	S-Nr. <b>8155207</b>			
Bearb.	espe					PSP / DPJ	VN	= B	Kamerainspektion
Erst.	espe						+ BX	Kamerainspektion	von 14
Ze.Nr.	Z13.E11	N:	F:	EPL0VZFG7M \\Festo.net\DFS01\INTData\EPLAN\DATA_xx\DE\Projects\Didactic\Products\26 CPAM\Cam\8155207_CP-AM-CAM-V2.elk					



Diese Zeichnung ist Eigentum der Festo Didactic SE

**-XD1**

/8.0

E/A-Modul Station  
In/Out-Module Station

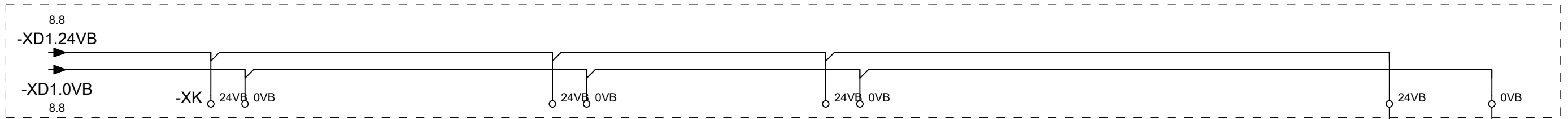

**-XD1**

E/A-Modul Station  
In/Out-Module Station

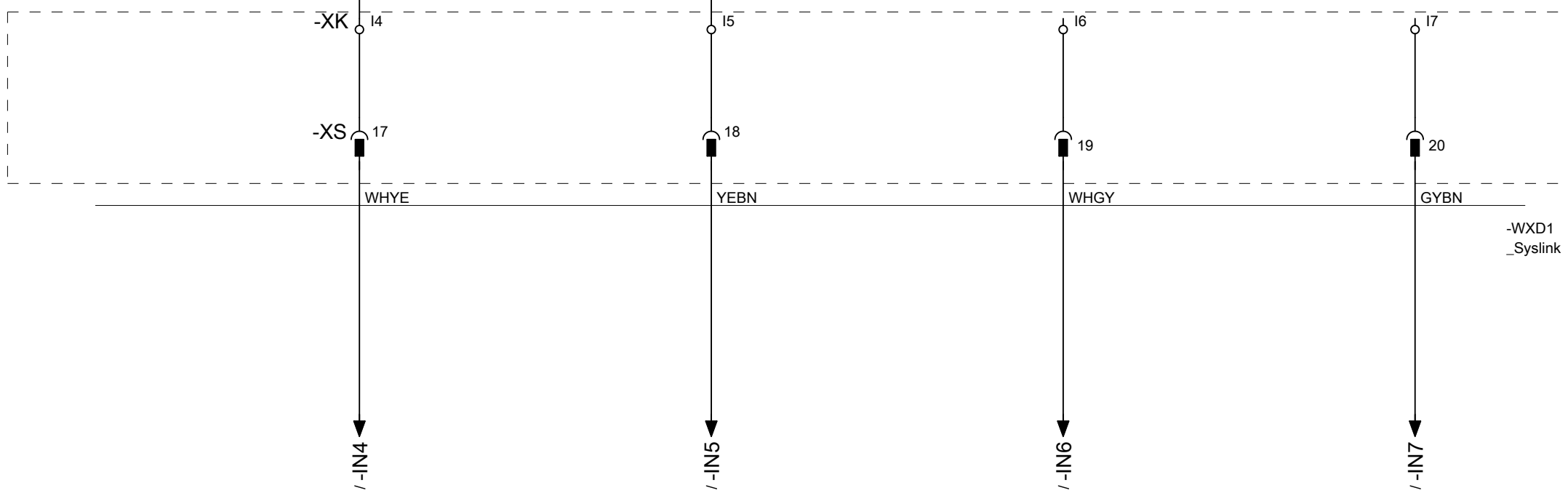

LED C

Beleuchtung  
Lighting

Reserve  
Reserve

Reserve  
Reserve

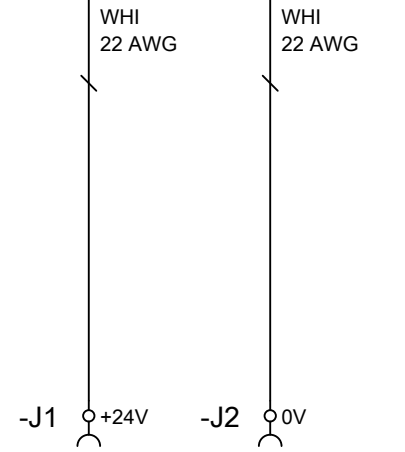

ROT  
RED

BLAU  
BLUE

Sicherheitsbuchsen  
Safety socket

Datum	30.04.2021
Bearb.	espe
Erst.	espe
Ze.Nr.	Z13.E11

Festo Didactic SE  
Rechbergstraße 3  
D-73770 Denkendorf



Eingänge  
inputs

S-Nr.	8155207
PSP / DPJ	VN

= B	Kamerainspektion	Seite 9
+ BX	Kamerainspektion	von 14

Diese Zeichnung ist Eigentum der Festo Didactic SE. This drawing is the property of Festo Didactic SE.

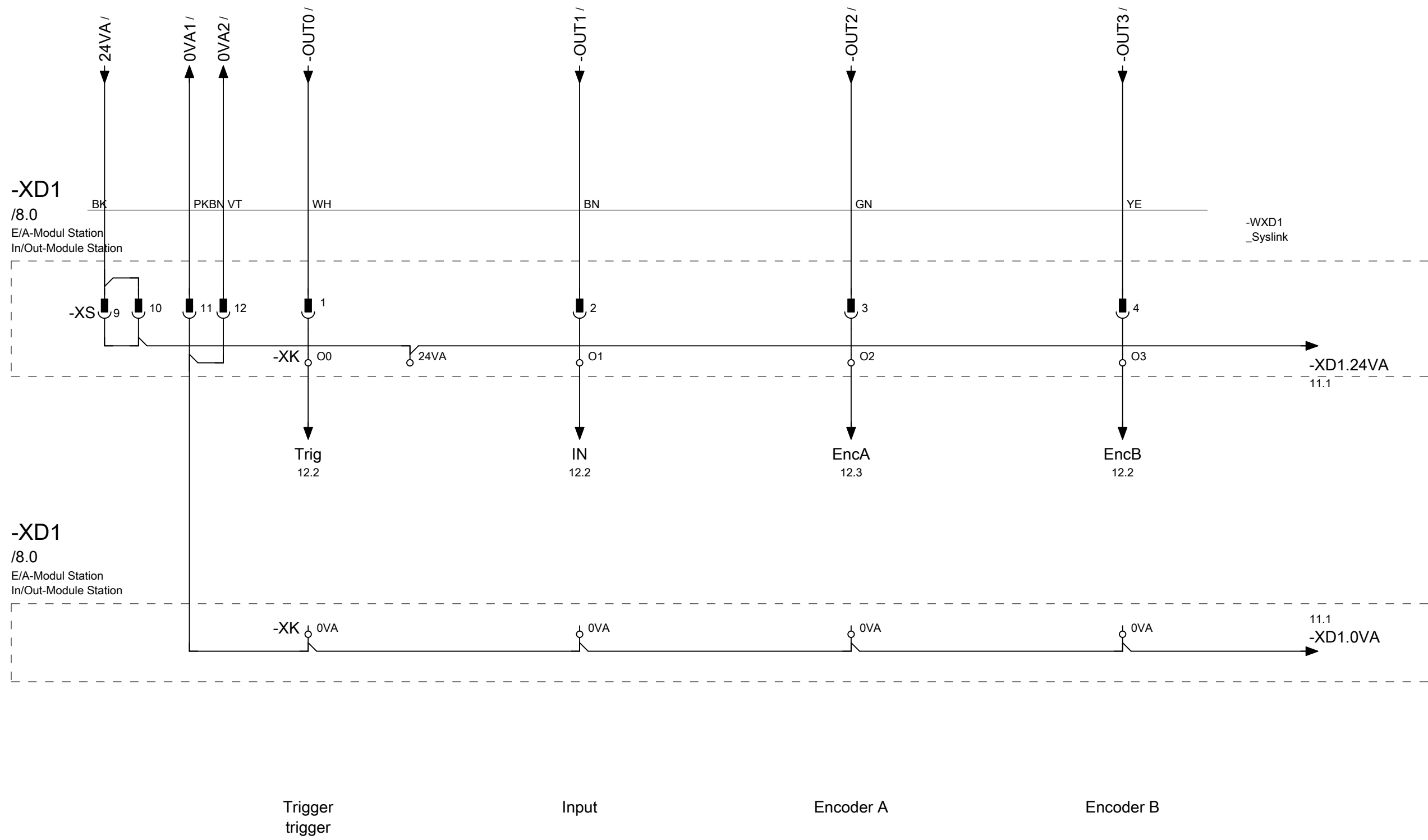

Trigger  
trigger

Input

Encoder A

Encoder B

Datum	30.04.2021	Festo Didactic SE Rechbergstraße 3 D-73770 Denkendorf		<b>FESTO</b>	Ausgänge outputs	S-Nr. <b>8155207</b>			
Bearb.	espe					PSP / DPJ	VN	= B	Kamerainspektion
Erst.	espe						+ BX	Kamerainspektion	von 14
Ze.Nr.	Z13.E11	N:	F:	EPL0VZFG7M \\Festo.net\DFS01\INTData\EPLAN\DATA_XX\DE\Projects\Didactic\Products\26 CPAM\Cam\8155207_CP-AM-CAM-V2.elk					

Diese Zeichnung ist Eigentum der Festo Didactic SE. This drawing is the property of Festo Didactic SE.

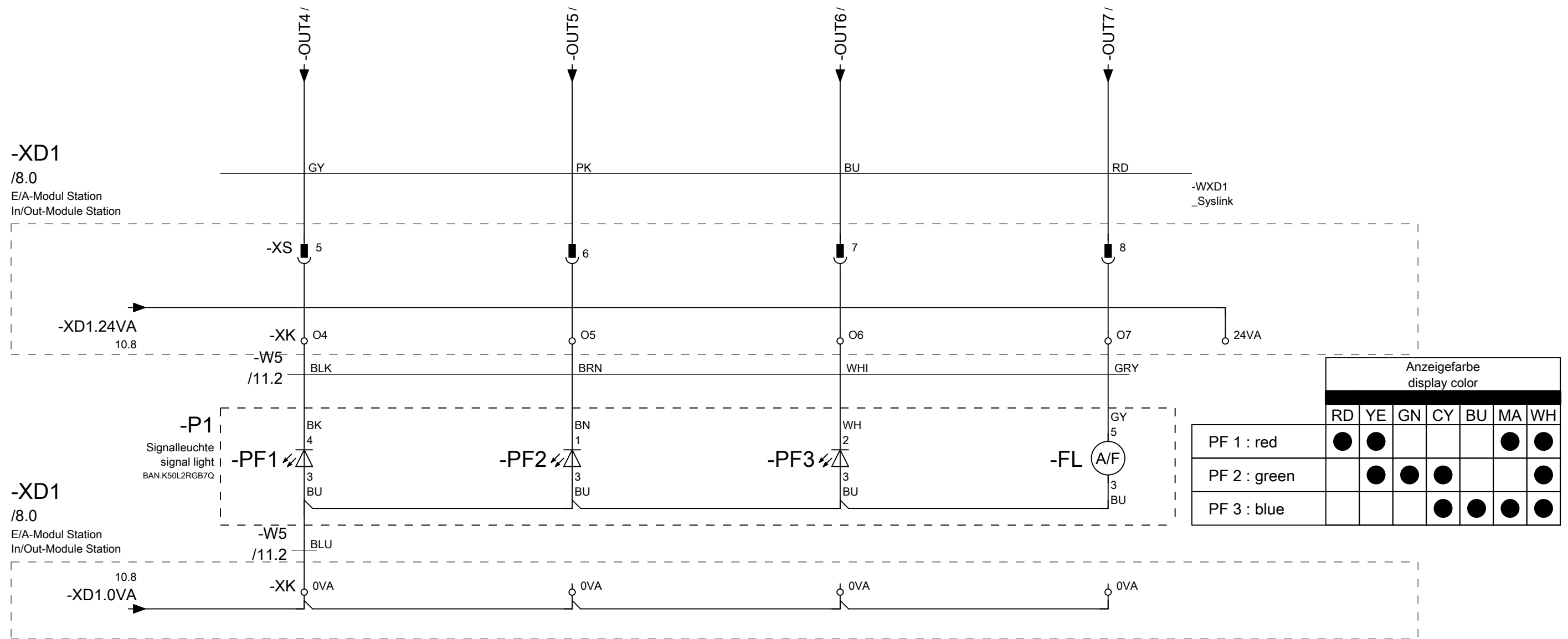

Anzeigefarbe display color							
	RD	YE	GN	CY	BU	MA	WH
PF 1 : red	●	●				●	●
PF 2 : green		●	●	●			●
PF 3 : blue				●	●	●	●

Grundfarbe rot  
basecolor red

Grundfarbe grün  
basecolor green

Grundfarbe blau  
basecolor blue

Blinken  
Flashing



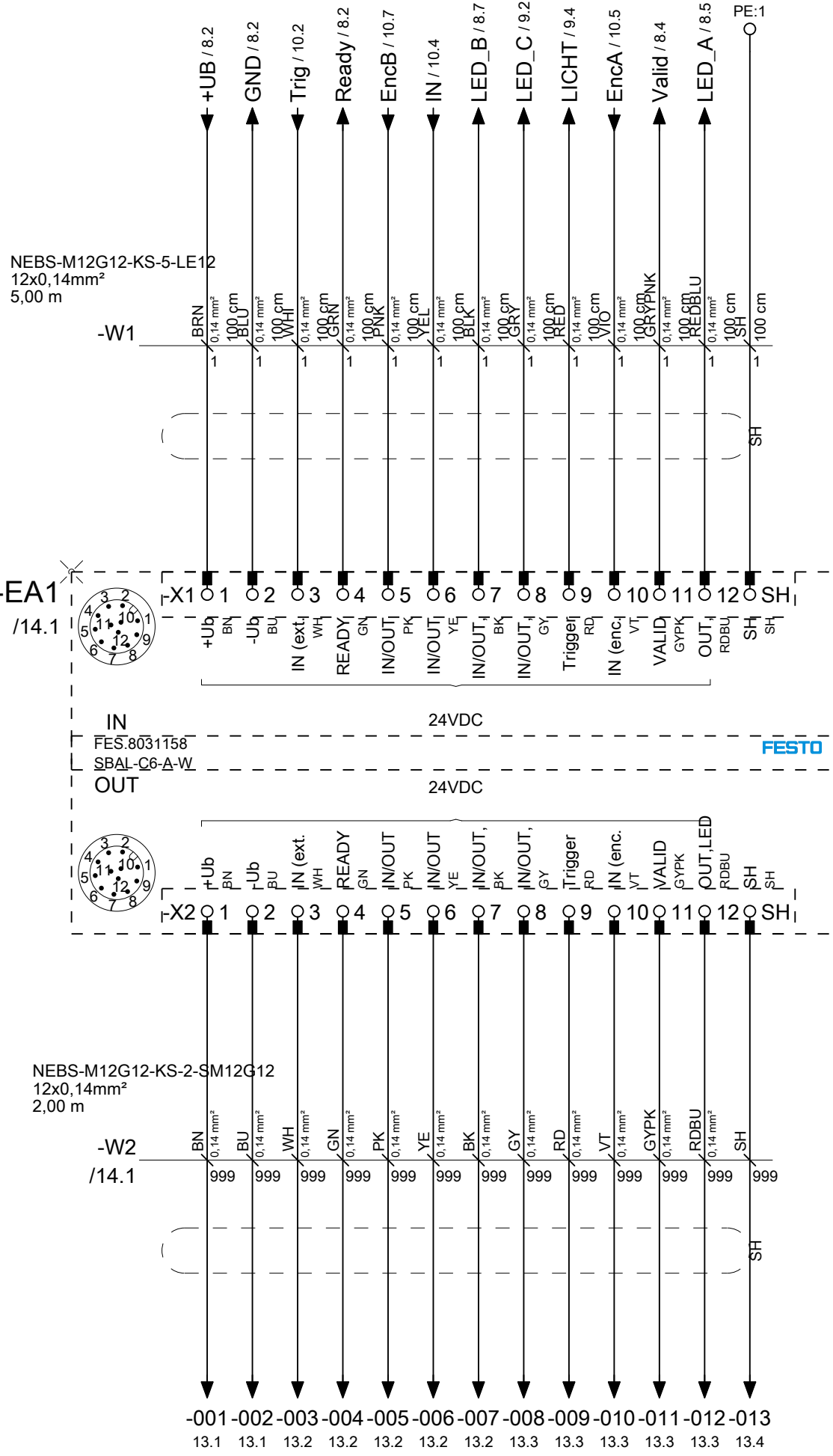

Datum	30.04.2021
Bearb.	espe
Erst.	espe
Ze.Nr.	Z13.E11

Festo Didactic SE  
Rechbergstraße 3  
D-73770 Denkendorf



Kamera  
camera

S-Nr.  
**8155207**  
PSP / DPJ VN

= B	Kamerainspektion	Seite 12
+ BX	Kamerainspektion	von 14

Diese Zeichnung ist Eigentum der Festo Didactic SE. This drawing is the property of Festo Didactic SE.

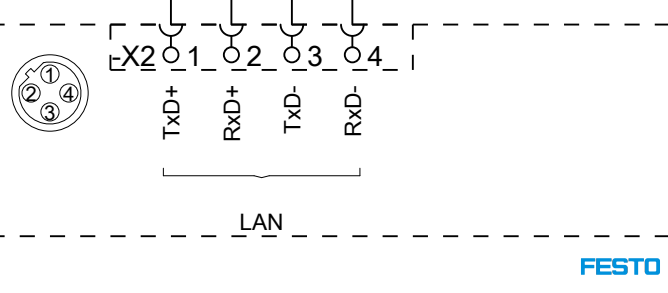
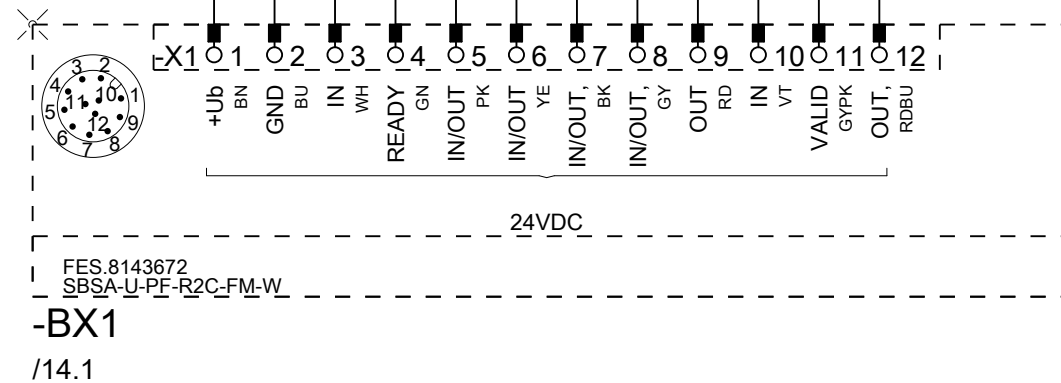
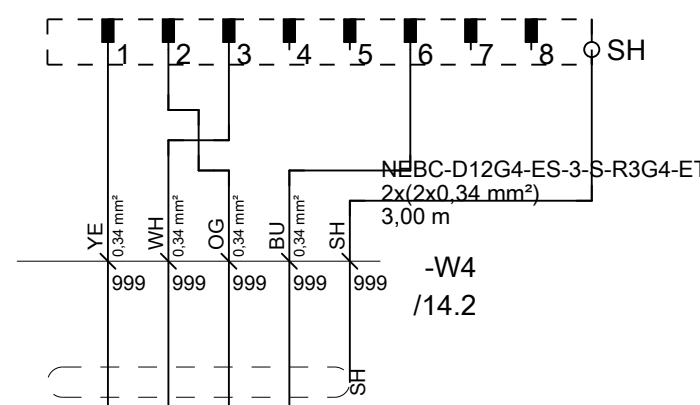
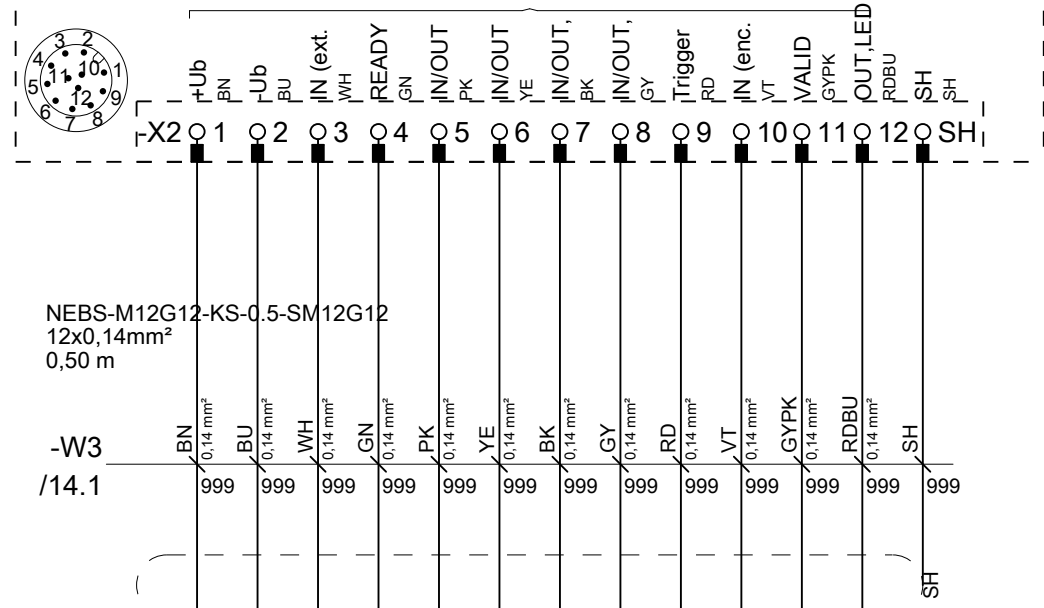
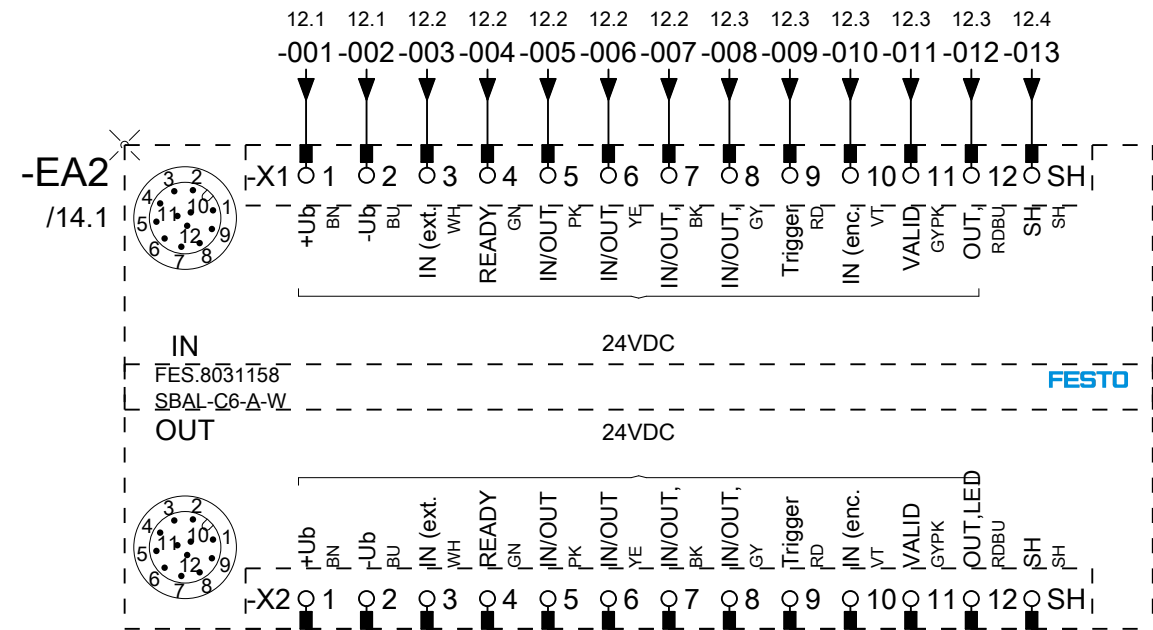

Datum	30.04.2021		Kamera camera	S-Nr.	8155207	= B + BX	Kamerainspektion Kamerainspektion	Seite 13 von 14
Bearb.	espe			PSP / DPJ	VN			
Erst.	espe							
Ze.Nr.	Z13.E11							

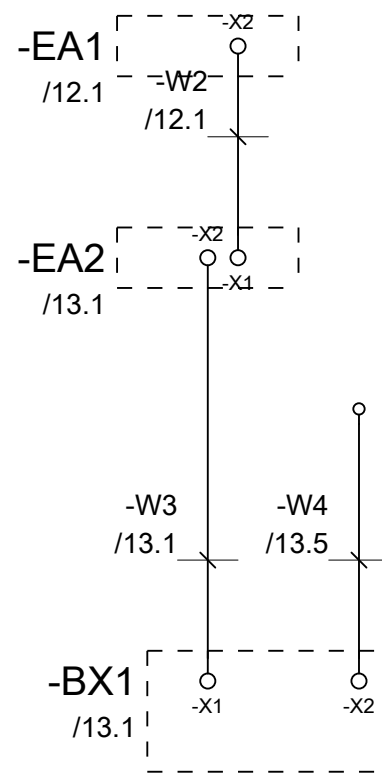

Datum	30.04.2021
Bearb.	espe
Erst.	espe
Ze.Nr.	Z13.E11

Festo Didactic SE  
 Rechbergstraße 3  
 D-73770 Denkendorf



Kabelübersicht  
 cable overview

S-Nr.  
**8155207**  
 PSP / DPJ VN

= B	Kamerainspektion	Seite 14
+ BX	Kamerainspektion	von 14